

Dimensions & Working Ranges

DIMENSIONS R210LC-9

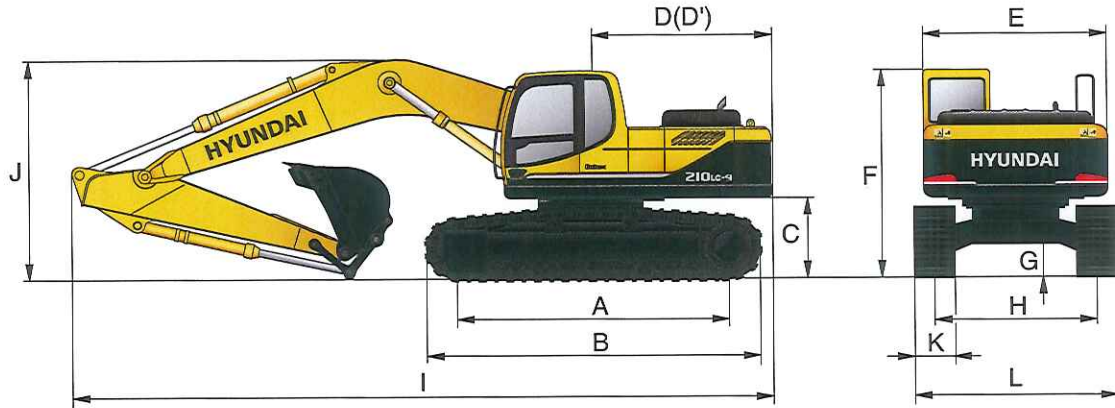

mm (ft · in)

mm (ft · in)

A Tumbler distance	3,650 (12' 0")					
B Overall length of crawler	4,440 (14' 7")					
C Ground clearance of counterweight	1,060 (3' 6")					
D Tail swing radius	2,840 (9' 4")					
D' Rear-end length	2,770 (9' 1")					
E Overall width of upperstructure	2,740 (9' 0")					
F Overall height of cab	2,920 (9' 7")					
G Min. ground clearance	480 (1' 7")					
H Track gauge	2,390 (7' 10")					
Boom length		5,680 (18' 8")				8,200 (26' 11")
Arm length		2,000 (6' 7")	2,400 (7' 10")	2,920 (9' 7")	3,900 (12' 10")	6,300 (20' 8")
I Overall length		9,650 (31' 8")	9,570 (31' 5")	9,530 (31' 3")	9,520 (31' 3")	12,030 (39' 6")
J Overall height of boom		3,200 (10' 6")	3,110 (10' 2")	3,030 (9' 11")	3,480 (11' 5")	3,280 (10' 9")
K Track shoe width		600 (24")	700 (28")	800 (32")	900 (36")	
L Overall width		2,990 (9' 10")	3,090 (10' 2")	3,190 (10' 6")	3,290 (10' 10")	

WORKING RANGES R210LC-9

mm (ft · in)

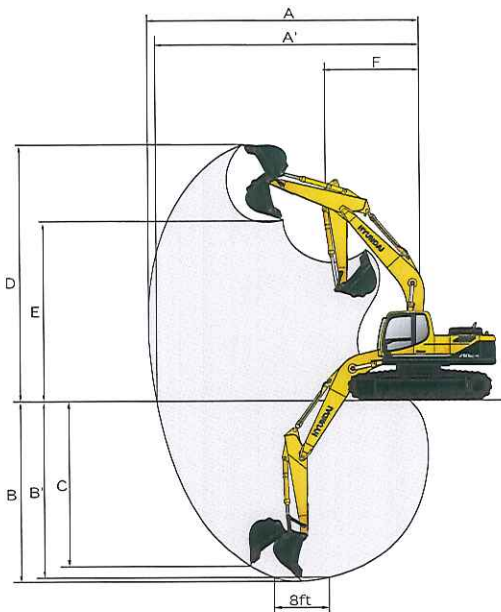

Boom length		5,680 (18' 8")				8,200 (26' 11")
Arm length		2,000 (6' 7")	2,400 (7' 10")	2,920 (9' 7")	3,900 (12' 10")	6,300 (20' 8")
A Max. digging reach		9,140 (30' 0")	9,500 (31' 2")	9,980 (32' 9")	10,910 (35' 10")	15,220 (50' 0")
A' Max. digging reach on ground		8,960 (29' 5")	9,330 (30' 7")	9,820 (32' 3")	10,770 (35' 4")	15,120 (49' 7")
B Max. digging depth		5,820 (19' 1")	6,220 (20' 5")	6,730 (22' 1")	7,720 (25' 4")	11,760 (38' 7")
B' Max. digging depth (8' level)		5,580 (18' 4")	6,010 (19' 9")	6,560 (21' 6")	7,580 (24' 10")	11,650 (38' 3")
C Max. vertical wall digging depth		5,280 (17' 4")	5,720 (18' 9")	6,280 (20' 7")	7,240 (23' 9")	9,610 (31' 6")
D Max. digging height		9,140 (30' 0")	9,340 (30' 8")	9,600 (31' 6")	10,110 (33' 2")	12,550 (41' 2")
E Max. dumping height		6,330 (20' 9")	6,520 (21' 5")	6,780 (22' 3")	7,290 (23' 11")	10,280 (33' 8")
F Min. swing radius		3,750 (12' 4")	3,740 (12' 3")	3,740 (12' 3")	3,650 (11' 12")	4,870 (16' 0")

Specifications

ENGINE

MODEL		CUMMINS QSB6.7	
Type		Water cooled, 4 cycle Diesel, 6-Cylinders in line, direct injection, turbocharged, charged air cooled and low emission	
Rated flywheel horse power	SAE	J1995 (gross)	151 HP (113 kW) / 1,900 rpm
		J1349 (net)	143 HP (107 kW) / 1,900 rpm
	DIN	6271/1 (gross)	153 PS (113 kW) / 1,900 rpm
		6271/1 (net)	145 PS (107 kW) / 1,900 rpm
Max. torque		63.6 kgf.m (460 lbf.ft) / 1,500 rpm	
Bore x stroke		107 x 124 mm (4.2" x 4.9")	
Piston displacement		6,700 cc (409 in ³)	
Batteries		2 X 12V X 100AH	
Starting motor		24 V - 4.5 kW	
Alternator		24 V - 50 Amp	

HYDRAULIC SYSTEM

MAIN PUMP	
Type	Two variable displacement piston pumps
Max. flow	2 X 222 L /min (58.6 US gpm / 48.8 UK gpm)
Sub-pump for pilot circuit	Gear pump
Cross-sensing and fuel saving pump system	
HYDRAULIC MOTORS	
Travel	Two speed axial piston motor with brake valve and parking brake
Swing	Axial piston motor with automatic brake
RELIEF VALVE SETTING	
Implement circuits	350 kgf/cm ² (4,978 psi)
Travel	350 kgf/cm ² (4,978 psi)
Power boost (boom, arm, bucket)	380 kgf/cm ² (5,404 psi)
Swing circuit	265 kgf/cm ² (3,769 psi)
Pilot circuit	40 kgf/cm ² (568 psi)
Service valve	Installed
HYDRAULIC CYLINDERS	
No. of cylinder-bore x stroke	Boom : 2 - 120 x 1,290 mm (4.7" x 50.8") Arm : 1 - 140 x 1,510 mm (5.5" x 59.4") Bucket : 1 - 120 x 1,055 mm (4.7" x 41.5")

DRIVES & BRAKES

Drive method	Fully hydrostatic type
Drive motor	Axial piston motor, in-shoe design
Reduction system	Planetary reduction gear
Max. drawbar pull	21,100 kgf (46,500 lbf)
Max. travel speed (high) / (low)	5.3 km/hr (3.3 mph) / 3.4 km/hr (2.1 mph)
Gradeability	35° (70 %)
Parking brake	Multi wet disc

CONTROL

Pilot pressure operated joysticks and pedals with detachable lever provide almost effortless and fatigueless operation.

Pilot control	Two joysticks with one safety lever (LH): Swing and arm (RH): Boom and bucket (ISO)
Traveling and steering	Two levers with pedals
Engine throttle	Electric, Dial type
Lights	Two lights mounted on the boom, one light mounted in the battery box

SWING SYSTEM

Swing motor	Axial piston motor
Swing reduction	Planetary gear reduction
Swing bearing lubrication	Grease-bathed
Swing brake	Multi wet disc
Swing speed	12 rpm

COOLANT & LUBRICANT CAPACITY

Refilling	liter	US gal	UK gal
Fuel tank	400	105.7	88.0
Engine coolant	35	9.2	7.7
Engine oil	24	6.3	5.3
Swing device - gear oil	5	1.3	1.1
Final drive (each) - gear oil	5.8	2	1
Hydraulic system (including tank)	290	76.6	63.8
Hydraulic tank	160	42.3	35.2

UNDERCARRIAGE

The X-leg type center frame is integrally welded with reinforced box-section track frames. The undercarriage includes lubricated rollers, idlers, track adjusters with shock absorbing springs and sprockets, and a track chain with double or triple grouser shoes.

Center frame	X - leg type
Track frame	Pentagonal box type
No. of shoes on each side	49
No. of carrier rollers on each side	2
No. of track rollers on each side	9
No. of rail guards on each side	2

OPERATING WEIGHT (APPROXIMATE)

Operating weight, including 5,680 mm (18' 8") boom, 2,920 mm (9' 7") arm, SAE heaped 0.92 m³ (1.20 yd³) bucket, lubricant, coolant, full fuel tank, full hydraulic tank, and all standard equipments.

MAJOR COMPONENT WEIGHT

Upperstructure	5,850 kg (12,900 lb)
Counterweight	3,800 kg (8,380 lb)
Boom (with arm cylinder)	1,950 kg (4,300 lb)
Arm (with bucket cylinder)	1,095 kg (2,410 lb)

OPERATING WEIGHT

Shoes			Operating weight		Ground pressure	
Type	Width mm (in)		kg (lb)	kgf/cm ² (psi)		
Triple grouser	600 (24")	R210LC-9	21,900 (48,280)	0.46 (6.54)		
		R210LC-9 H/W	23,360 (51,500)	0.50 (7.11)		
	700 (28")	R210LC-9	22,250 (49,050)	0.40 (5.69)		
		R210LC-9 H/W	23,710 (52,270)	0.43 (6.11)		
	800 (32")	R210LC-9	22,515 (49,640)	0.36 (5.12)		
		R210LC-9 H/W	23,975 (52,855)	0.38 (5.40)		
900 (36")	R210LC-9	22,780 (50,220)	0.32 (4.55)			
	R210LC-9 H/W	24,135 (53,210)	0.43 (6.11)			
Double grouser	710 (28")	R210LC-9 H/W	24,135 (53,210)	0.43 (6.11)		

BUCKETS

All buckets are welded with high-strength steel



0.51 (0.67)



0.80 (1.05)
0.92 (1.20)



1.10 (1.44)
1.20 (1.57)



1.34 (1.75)



◆ 0.74 (0.97)
◆ 0.90 (1.18)
◆ 1.05 (1.37)



◎ 0.87 (1.14)
◎ 1.20 (1.57)



▣ 0.75 (0.98)



★ 0.52 (0.68)

SAE heaped m³ (yd³)

Capacity m ³ (yd ³)		Width mm (in)		Weight kg (lb)	Recommendation m (ft.in)				
SAE heaped	CECE heaped	Without side cutters	With side cutters		5.68 (18' 8") Boom				8.2 (26' 11") Boom
					2.0 (6' 7") Arm	2.4 (7' 10") Arm	2.92 (9' 7") Arm	3.9 (12' 10") Arm	6.3 (20' 8") Arm
0.51 (0.67)	0.45 (0.59)	700 (27.6)	820 (32.3)	570 (1,260)	●	●	●	●	-
0.80 (1.05)	0.70 (0.92)	1,000 (39.4)	1,120 (44.1)	700 (1,540)	●	●	●	■	-
0.92 (1.20)	0.80 (1.05)	1,150 (45.3)	1,270 (50.0)	770 (1,700)	●	●	■	▲	-
1.10 (1.44)	0.96 (1.26)	1,320 (52.0)	1,440 (56.7)	830 (1,830)	■	▲	▲	-	-
1.20 (1.57)	1.00 (1.31)	1,400 (55.1)	1,520 (59.8)	850 (1,870)	■	▲	-	-	-
1.34 (1.75)	1.15 (1.50)	1,550 (61.0)	1,670 (65.7)	920 (2,030)	▲	▲	-	-	-
◆ 0.74 (0.97)	0.65 (0.85)	985 (38.8)	-	770 (1,700)	●	●	●	▲	-
◆ 0.90 (1.18)	0.80 (1.05)	1,070 (42.0)	-	810 (1,790)	●	●	■	-	-
◆ 1.05 (1.37)	0.92 (1.20)	1,290 (50.8)	-	890 (1,960)	■	▲	-	-	-
◎ 0.87 (1.14)	0.75 (0.98)	1,140 (44.9)	-	900 (1,980)	●	●	■	-	-
◎ 1.20 (1.57)	1.00 (1.31)	1,410 (55.5)	-	1,030 (2,270)	■	▲	-	-	-
▣ 0.75 (0.98)	0.65 (0.85)	1,790 (70.5)	-	880 (1,940)	●	●	■	▲	-
★ 0.52 (0.68)	0.45 (0.59)	935 (36.8)	1,035 (40.8)	460 (1,010)	-	-	-	-	▲

◆ Heavy-duty bucket

▣ Slope finishing bucket

● Applicable for materials with density of 2,000 kg/m³ (3,370 lb/yd³) or less

◎ Heavy duty Rock-bucket

★ Long Reach bucket

■ Applicable for materials with density of 1,600 kg/m³ (2,700 lb/yd³) or less

▲ Applicable for materials with density of 1,100 kg/m³ (1,850 lb/yd³) or less

ATTACHMENT

Booms and arms are welded, a low-stress, full-box section design. 5.68 m and 8.2 m booms and 2.0 m; 2.4 m; 2.92 m; 3.9 m & 6.3 m arms are available.

DIGGING FORCE

Boom	Length	mm (ft.in)	5,680 (18' 8")				8,200 (26' 11")	Remarks
	Weight	kg (lb)	1,950 (4,300)				2,350 (5,180)	
Arm	Length	mm (ft.in)	2,000 (6' 7")	2,400 (7' 10")	2,920 (9' 7")	3,900 (12' 10")	6,300 (20' 8")	
	Weight	kg (lb)	975 (2,150)	1,045 (2,300)	1,095 (2,410)	1,295 (2,850)	1,330 (2,930)	
Bucket digging force	SAE	kN	130.4 [141.6]	130.4 [141.6]	130.4 [141.6]	130.4 [141.6]	72.6	[]: Power Boost
		kgf	13300 [14,440]	13300 [14440]	13300 [14440]	13300 [14440]	7400	
		lbf	29320 [31830]	29320 [31830]	29320 [31830]	29320 [31830]	16310	
	ISO	kN	149.1 [161.8]	149.1 [161.8]	149.1 [161.8]	149.1 [161.8]	83.4	
		kgf	15200 [16500]	15200 [16500]	15200 [16500]	15200 [16500]	8500	
		lbf	33510 [36380]	33510 [36380]	33510 [36380]	33510 [36380]	18740	
Arm crowd force	SAE	kN	144.2 [156.5]	119.6 [129.9]	102.0 [110.7]	84.3 [91.6]	49.0	
		kgf	14700 [15960]	12200 [13250]	10400 [11290]	8600 [9340]	5000	
		lbf	32410 [35190]	26900 [29210]	22930 [24900]	18960 [20590]	11020	
	ISO	kN	151.0 [164.0]	125.5 [136.3]	106.9 [116.1]	87.3 [94.8]	50.0	
		kgf	15400 [16720]	12800 [13900]	10900 [11830]	8900 [9660]	5100	
		lbf	33950 [36860]	28220 [30640]	24030 [26090]	19620 [21300]	11240	

Note: Boom weight includes arm cylinder, piping, and pin

Arm weight includes bucket cylinder, linkage, and pin

Dimensions & Working Ranges

DIMENSIONS R210LC-9 HIGH WALKER

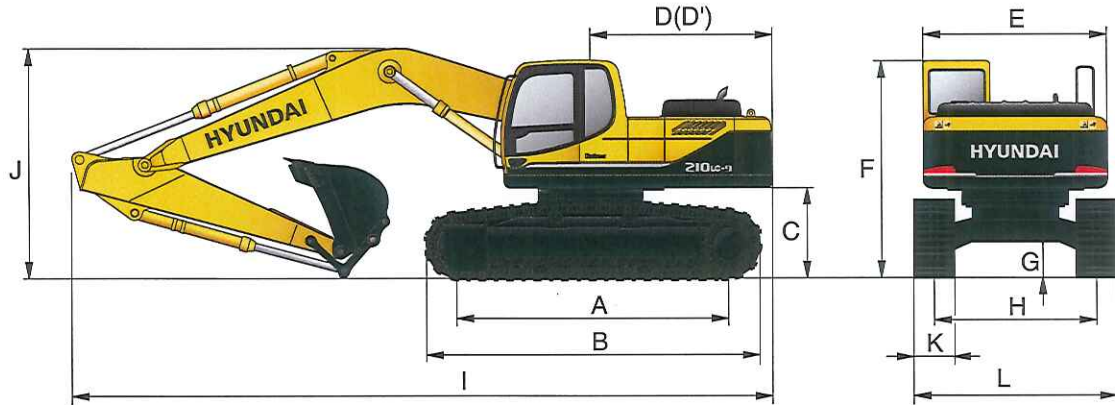

mm (ft · in)

mm (ft · in)

A Tumbler distance	3,650 (12' 0")
B Overall length of crawler	4,440 (14' 7")
C Ground clearance of counterweight	1,240 (4' 1")
D Tail swing radius	2,840 (9' 4")
D' Rear-end length	2,770 (9' 1")
E Overall width of upperstructure	2,740 (9' 0")
F Overall height of cab	3,100 (10' 2")
G Min. ground clearance	660 (2' 2")
H Track gauge	2,795 (9' 2")

Boom length	5,680 (18' 8")				
Arm length	2,000 (6' 7")	2,400 (7' 10")	2,920 (9' 7")	3,900 (12' 10")	
I Overall length	9,650 (31' 8")	9,550 (31' 4")	9,470 (31' 1")	9,560 (31' 4")	
J Overall height of boom	3,290 (10' 10")	3,170 (10' 5")	3,060 (10' 0")	3,450 (11' 4")	
K Track shoe width	Type	Triple grouser			Double grouser
	Width	600 (24")	700 (28")	800 (32")	710 (28")
L Overall width	3,395 (11' 2")	3,495 (11' 6")	3,595 (12' 0")	3,505 (11' 6")	

WORKING RANGES R210LC-9 HIGH WALKER

mm (ft · in)

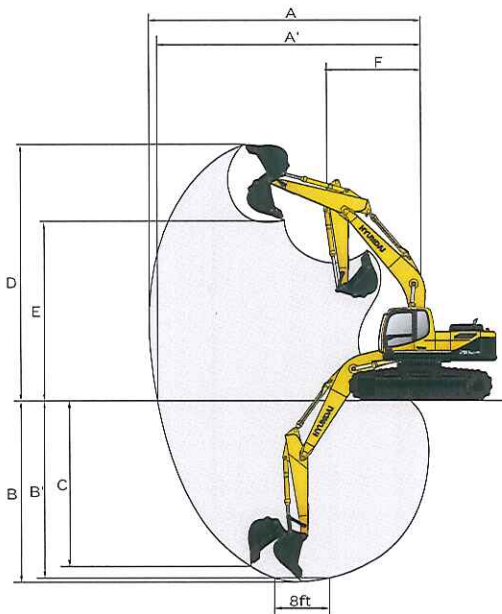

Boom length	5,680 (18' 8")			
Arm length	2,000 (6' 7")	2,400 (7' 10")	2,920 (9' 7")	3,900 (12' 10")
A Max. digging reach	9,140 (30' 0")	9,500 (31' 2")	9,980 (32' 9")	10,910 (35' 10")
A' Max. digging reach on ground	8,920 (29' 3")	9,290 (30' 6")	9,820 (32' 3")	10,730 (35' 2")
B Max. digging depth	5,630 (18' 6")	6,010 (19' 9")	6,550 (21' 6")	7,530 (24' 8")
B' Max. digging depth (8' level)	5,390 (17' 8")	5,820 (19' 1")	6,380 (20' 11")	7,390 (24' 3")
C Max. vertical wall digging depth	5,090 (16' 8")	5,630 (18' 6")	6,100 (20' 0")	7,050 (23' 1")
D Max. digging height	9,330 (30' 7")	9,530 (31' 3")	9,780 (32' 1")	10,300 (33' 9")
E Max. dumping height	6,520 (21' 5")	6,710 (22' 0")	6,960 (22' 10")	7,480 (24' 6")
F Min. swing radius	3,750 (12' 4")	3,740 (12' 3")	3,740 (12' 3")	3,650 (11' 12")

Lifting Capacities

R210LC-9



Rating over-front



Rating over-side or 360 degrees

Boom : 5.68 m (18' 8") / Arm : 2.0 m (6' 7") / Bucket : 0.92 m³ (1.20 yd³) SAE heaped / Shoe : 600 mm (24") triple grouser with 3,800 kg (8,380 lb) Counterweight

Load point height m (ft)		Load radius								At max. reach		
		3.0 m (10.0 ft)		4.5 m (15.0 ft)		6.0 m (20.0 ft)		7.5 m (25.0 ft)		Capacity		Reach m (ft)
7.5 m (25.0 ft)	kg lb									*4010 *8840	*4010 *8840	6.65 (21.8)
6.0 m (20.0 ft)	kg lb					*4440 *9790	*4440 *9790			*4060 *8950	3040 6700	7.78 (25.5)
4.5 m (15.0 ft)	kg lb			*5730 *12630	*5730 *12630	*4860 *10710	4630 10210			*4190 *9240	2540 5600	8.43 (27.7)
3.0 m (10.0 ft)	kg lb			*7460 *16450	6840 15080	*5610 *12370	4370 9630	*4830 *10650	3000 6610	4040 8910	2310 5090	8.74 (28.7)
1.5 m (5.0 ft)	kg lb			*8990 *19820	6320 13930	*6390 *14090	4120 9080	5060 11160	2890 6370	3990 8800	2260 4980	8.73 (28.6)
Ground Line	kg lb			*9690 *21360	6090 13430	*6910 *15230	3950 8710	4980 10980	2810 6190	4200 9260	2380 5250	8.42 (27.6)
-1.5 m (-5.0 ft)	kg lb	*13990 *30840	12260 27030	*9630 *21230	6070 13380	*6990 *15410	3910 8620			4820 10630	2750 6060	7.76 (25.5)
-3.0 m (-10.0 ft)	kg lb	*12500 *27560	12500 27560	*8820 *19440	6180 13620	*6350 *14000	3990 8800			*4850 *10690	3650 8050	6.61 (21.7)
-4.5 m (-15.0 ft)	kg lb	*9460 *20860	*9460 *20860									

Boom : 5.68 m (18' 8") / Arm : 2.4 m (7' 10") / Bucket : 0.92 m³ (1.20 yd³) SAE heaped / Shoe : 600 mm (24") triple grouser with 3,800 kg (8,380 lb) Counterweight

Load point height m (ft)		Load radius								At max. reach				
		1.5 m (5.0 ft)		3.0 m (10.0 ft)		4.5 m (15.0 ft)		6.0 m (20.0 ft)		7.5 m (25.0 ft)		Capacity		Reach m (ft)
7.5 m (25.0 ft)	kg lb											*3700 *8160	3640 8020	7.15 (23.5)
6.0 m (20.0 ft)	kg lb							*4010 *8840	*4010 *8840			*3780 *8330	2760 6080	8.20 (26.9)
4.5 m (15.0 ft)	kg lb							*4490 *9900	*4490 *9900	*4230 *9330	3130 6900	*3900 *8600	2340 5160	8.82 (28.9)
3.0 m (10.0 ft)	kg lb					*6900 *15210	*6900 *15210	*5280 *11640	4400 9700	*4560 *10050	3010 6640	3760 8290	2130 4700	9.11 (29.9)
1.5 m (5.0 ft)	kg lb					*8560 *18870	6380 14070	*6120 *13490	4130 9110	*4970 *10960	2880 6350	3710 8180	2080 4590	9.10 (29.9)
Ground Line	kg lb			*8790 *19380	*8790 *19380	*9490 *20920	6080 13400	*6740 *14860	3930 8660	4950 10910	2780 6130	3890 8580	2180 4810	8.81 (28.9)
-1.5 m (-5.0 ft)	kg lb	*9760 *21520	*9760 *21520	*13510 *29780	12060 26590	*9650 *21270	6000 13230	*6960 *15340	3850 8490			4390 9680	2480 5470	8.18 (26.8)
-3.0 m (-10.0 ft)	kg lb	*14150 *31200	*14150 *31200	*13240 *29190	12280 27070	*9090 *20040	6080 13400	*6590 *14530	3900 8600			*4700 *10360	3190 7030	7.12 (23.4)
-4.5 m (-15.0 ft)	kg lb			*10630 *23440	*10630 *23440	*7400 *16310	6330 13960							

Boom : 5.68 m (18' 8") / Arm : 2.92 m (9' 7") / Bucket : 0.92 m³ (1.20 yd³) SAE heaped / Shoe : 600 mm (24") triple grouser with 3,800 kg (8,380 lb) Counterweight

Load point height m (ft)		Load radius								At max. reach				
		1.5 m (5.0 ft)		3.0 m (10.0 ft)		4.5 m (15.0 ft)		6.0 m (20.0 ft)		7.5 m (25.0 ft)		Capacity		Reach m (ft)
7.5 m (25.0 ft)	kg lb											*3360 *7410	3150 6940	7.78 (25.5)
6.0 m (20.0 ft)	kg lb									*2340 *5160	*2340 *5160	*3450 *7610	2460 5420	8.74 (28.7)
4.5 m (15.0 ft)	kg lb							*4010 *8840	*4010 *8840	*3830 *8440	3180 7010	*3580 *7890	2100 4630	9.32 (30.6)
3.0 m (10.0 ft)	kg lb			*9780 *21560	*9780 *21560	*6150 *13560	*6150 *13560	*4840 *10670	4460 9830	*4230 *9330	3040 6700	3440 7580	1930 4250	9.59 (31.5)
1.5 m (5.0 ft)	kg lb			*8810 *19420	*8810 *19420	*7960 *17550	6490 14310	*5750 *12680	4160 9170	*4710 *10380	2880 6350	3390 7470	1880 4140	9.59 (31.5)
Ground Line	kg lb			*9550 *21050	*9550 *21050	*9160 *20190	6090 13430	*6490 *14310	3920 8640	4930 10870	2750 6060	3520 7760	1950 4300	9.31 (30.5)
-1.5 m (-5.0 ft)	kg lb	*8810 *19420	*8810 *19420	*12610 *27800	11870 26170	*9600 *21160	5940 13100	*6870 *15150	3800 8380	4860 10710	2690 5930	3920 8640	2190 4830	8.72 (28.6)
-3.0 m (-10.0 ft)	kg lb	*12190 *26870	*12190 *26870	*13980 *30820	12040 26540	*9320 *20550	5960 13140	*6740 *14860	3800 8380			*4460 *9830	2710 5970	7.75 (25.4)
-4.5 m (-15.0 ft)	kg lb			*11860 *26150	*11860 *26150	*8120 *17900	6140 13540					*4330 *9550	4080 8990	6.16 (20.2)















- Lifting capacity is based on SAE J1097, ISO 10567.
- Lifting capacity of the Robex Series does not exceed 75% of the tipping load with the machine on firm, level ground or 87% of full hydraulic capacity.
- The load point is a hook located on the back of the bucket.
- (*) indicates the load limited by hydraulic capacity.

Lifting Capacities

R210LC-9

 Rating over-front  Rating over-side or 360 degrees











Boom : 5.68 m (18' 8") / Arm : 3.9 m (12' 10") / Bucket : 0.92 m³ (1.20 yd³) SAE heaped / Shoe : 600 mm (24") triple grouser with 3,800 kg (8,380 lb) Counterweight

Load point height m (ft)		Load radius										At max. reach				
		1.5 m (5.0 ft)		3.0 m (10.0 ft)		4.5 m (15.0 ft)		6.0 m (20.0 ft)		7.5 m (25.0 ft)		9.0 m (30.0 ft)		Capacity	Reach	
																m (ft)
9.0 m (30.0 ft)	kg lb													*2740 *6040	*2740 *6040	7.66 (25.1)
7.5 m (25.0 ft)	kg lb								*1980 *4370	*1980 *4370				*2800 *6170	2420 5340	8.94 (29.3)
6.0 m (20.0 ft)	kg lb								*2840 *6260	*2840 *6260				*2900 *6390	1960 4320	9.77 (32.1)
4.5 m (15.0 ft)	kg lb								*3090 *6810	*3090 *6810	*2040 *4500	*2040 *4500	*3020 *6660	1700 3750	10.28 (33.7)	
3.0 m (10.0 ft)	kg lb						*3940 *8690	*3940 *8690	*3560 *7850	3080 6790	*2910 *6420	2140 4720	2890 6370	1560 3440	10.52 (34.5)	
1.5 m (5.0 ft)	kg lb			*11130 *24540	*11130 *24540	*6640 *14640	*6640 *14640	*4950 *10910	4220 9300	*4120 *9080	2880 6350	*3450 *7610	2040 4500	2840 6260	1510 3330	10.52 (34.5)
Ground Line	kg lb	*5260 *11600	*5260 *11600	*10600 *23370	*10600 *23370	*8250 *18190	6130 13510	*5860 *12920	3910 8620	*4650 *10250	2710 5970	*3530 *7780	1950 4300	2930 6460	1550 3420	10.27 (33.7)
-1.5 m (-5.0 ft)	kg lb	*7500 *16530	*7500 *16530	*11650 *25680	11540 25440	*9150 *20170	5810 12810	*6490 *14310	3700 8160	4750 10470	2590 5710	*2370 *5220	1900 4190	3180 7010	1700 3750	9.75 (32.0)
-3.0 m (-10.0 ft)	kg lb	*9990 *22020	*9990 *22020	*14350 *31640	11540 25440	*9360 *20640	5720 12610	*6700 *14770	3620 7980	4710 10380	2550 5620			3710 8180	2030 4480	8.91 (29.2)
-4.5 m (-15.0 ft)	kg lb	*12960 *28570	*12960 *28570	*13360 *29450	11780 25970	*8830 *19470	5800 12790	*6340 *13980	3670 8090					*4030 *8880	2730 6020	7.62 (25.0)
-6.0 m (-20.0 ft)	kg lb			*10610 *23390	*10610 *23390	*7100 *15650	6080 13400									













R210LC-9 HIGH WALKER

 Rating over-front  Rating over-side or 360 degrees

Boom : 5.68 m (18' 8") / Arm : 2.4 m (7' 10") / Bucket : 0.92 m³ (1.20 yd³) SAE heaped / Shoe : 600 mm (24") triple grouser with 3,800 kg (8,380 lb) Counterweight

Load point height m (ft)		Load radius										At max. reach				
		1.5 m (5.0 ft)		3.0 m (10.0 ft)		4.5 m (15.0 ft)		6.0 m (20.0 ft)		7.5 m (25.0 ft)		Capacity	Reach			
														m (ft)		
7.5 m (25.0 ft)	kg lb													*3700 *8160	*3700 *8160	7.31 (24.0)
6.0 m (20.0 ft)	kg lb							*4050 *8930	*4050 *8930					*3790 *8360	3480 7670	8.30 (27.2)
4.5 m (15.0 ft)	kg lb					*5360 *11820	*5360 *11820	*4580 *10100	*4580 *10100	*4260 *9390	4030 8880			*3920 *8640	3020 6660	8.87 (29.1)
3.0 m (10.0 ft)	kg lb					*7130 *15720	*7130 *15720	*5390 *11880	*5390 *11880	*4610 *10160	3900 8600			4010 8840	2810 6190	9.12 (29.9)
1.5 m (5.0 ft)	kg lb					*8720 *19220	8370 18450	*6220 *13710	5360 11820	*5020 *11070	3770 8310			3990 8800	2780 6130	9.08 (29.8)
Ground Line	kg lb			*9350 *20610	*9350 *20610	*9550 *21050	8080 17810	*6790 *14970	5170 11400	5290 11660	3670 8090			4210 9280	2940 6480	8.75 (28.7)
-1.5 m (-5.0 ft)	kg lb	*10290 *22690	*10290 *22690	*14180 *31260	*14180 *31260	*9620 *21210	8020 17680	*6950 *15320	5100 11240					*4650 *10250	3360 7410	8.07 (26.5)
-3.0 m (-10.0 ft)	kg lb	*14760 *32540	*14760 *32540	*12990 *28640	*12990 *28640	*8950 *19730	8120 17900	*6470 *14260	5170 11400					*4690 *10340	4350 9590	6.94 (22.8)
-4.5 m (-15.0 ft)	kg lb			*10150 *22380	*10150 *22380	*7020 *15480	*7020 *15480									

Boom : 5.68 m (18' 8") / Arm : 2.92 m (9' 7") / Bucket : 0.92 m³ (1.20 yd³) SAE heaped / Shoe : 600 mm (24") triple grouser with 3,800 kg (8,380 lb) Counterweight















Load point height m (ft)		Load radius										At max. reach				
		1.5 m (5.0 ft)		3.0 m (10.0 ft)		4.5 m (15.0 ft)		6.0 m (20.0 ft)		7.5 m (25.0 ft)		Capacity	Reach			
														m (ft)		
7.5 m (25.0 ft)	kg lb													*3370 *7430	*3370 *7430	7.93 (26.0)
6.0 m (20.0 ft)	kg lb									*2700 *5950	*2700 *5950	*3460 *7630	3130 6900	8.83 (29.0)		
4.5 m (15.0 ft)	kg lb					*4110 *9060	*4110 *9060	*3870 *8530	*3870 *8530	*3600 *7940	2740 6040			2560 6040	9.37 (30.7)	
3.0 m (10.0 ft)	kg lb			*10440 *23020	*10440 *23020	*6400 *14110	*6400 *14110	*4960 *10930	*4960 *10930	*4290 *9460	3930 8660			3680 8110	2560 5640	9.60 (31.5)
1.5 m (5.0 ft)	kg lb			*8610 *18980	*8610 *18980	*8150 *17970	*8150 *17970	*5860 *12920	5380 11860	*4760 *10490	3770 8310			3650 8050	2530 5580	9.57 (31.4)
Ground Line	kg lb			*9870 *21760	*9870 *21760	*9260 *20410	8080 17810	*6560 *14460	5150 11350	*5150 *11350	3640 8020			3820 8420	2650 5840	9.25 (30.3)
-1.5 m (-5.0 ft)	kg lb	*9210 *20300	*9210 *20300	*13090 *28860	*13090 *28860	*9600 *21160	7940 17500	*6880 *15170	5040 11110	5200 11460	3590 7910			4280 9440	2980 6570	8.62 (28.3)
-3.0 m (-10.0 ft)	kg lb	*12660 *27910	*12660 *27910	*13780 *30380	*13780 *30380	*9230 *20350	7990 17610	*6670 *14700	5060 11160					*4470 *9850	3710 8180	7.59 (24.9)
-4.5 m (-15.0 ft)	kg lb			*11470 *25290	*11470 *25290	*7860 *17330	*7860 *17330							*4250 *9370	*4250 *9370	5.89 (19.3)

Lifting Capacities













R210LC-9 HIGH WALKER

 Rating over-front  Rating over-side or 360 degrees













Boom : 5.68 m (18' 8") / Arm : 3.9 m (12' 10") / Bucket : 0.92 m³ (1.20 yd³) SAE heaped / Shoe : 600 mm (24") triple grouser with 3,800 kg (8,380 lb) Counterweight

Load point height m (ft)		Load radius										At max. reach				
		1.5 m (5.0 ft)		3.0 m (10.0 ft)		4.5 m (15.0 ft)		6.0 m (20.0 ft)		7.5 m (25.0 ft)		9.0 m (30.0 ft)		Capacity	Reach	
																m (ft)
9.0 m (30.0 ft)	kg lb													*2750 *6060	*2750 *6060	7.86 (25.8)
7.5 m (25.0 ft)	kg lb								*2220 *4890	*2220 *4890				*2810 *6190	*2810 *6190	9.06 (29.7)
6.0 m (20.0 ft)	kg lb								*2850 *6280	*2850 *6280				*2910 *6420	2550 5620	9.85 (32.3)
4.5 m (15.0 ft)	kg lb								*3140 *6920	*3140 *6920	*2180 *4810	*2180 *4810	*3030 *6680	2270 5000	10.33 (33.9)	
3.0 m (10.0 ft)	kg lb						*4060 *8950	*4060 *8950	*3620 *7980	*3620 *7980	*2990 *6590	2840 6260	3100 6830	2120 4670	10.54 (34.6)	
1.5 m (5.0 ft)	kg lb			*11630 *25640	*11630 *25640	*6880 *15170	*6880 *15170	*5070 *11180	*5070 *11180	*4190 *9240	*3770 8310	*3490 *7690	2730 6020	3070 6770	2090 4610	10.50 (34.4)
Ground Line	kg lb	*5540 *12210	*5540 *12210	*10590 *23350	*10590 *23350	*8400 *18520	8100 17860	*5960 *13140	5130 11310	*4710 *10380	3590 7910	*3480 *7670	2640 5820	3180 7010	2160 4760	10.22 (33.5)
-1.5 m (-5.0 ft)	kg lb	*7800 *17200	*7800 *17200	*11920 *26280	*11920 *26280	*9220 *20330	7800 17200	*6540 *14420	4940 10890	*5060 *11160	3480 7670			3480 7670	2370 5220	9.67 (31.7)
-3.0 m (-10.0 ft)	kg lb	*10330 *22770	*10330 *22770	*14530 *32030	*14530 *32030	*9340 *20590	7730 17040	*6690 *14750	4870 10740	5060 11160	3450 7610			*3920 *8640	2820 6220	8.78 (28.8)
-4.5 m (-15.0 ft)	kg lb	*13390 *29520	*13390 *29520	*13120 *28920	*13120 *28920	*8690 *19160	7840 17280	*6230 *13730	4940 10890					*4030 *8880	3800 8380	7.41 (24.3)
-6.0 m (-20.0 ft)	kg lb			*10090 *22240	*10090 *22240	*6720 *14820	*6720 *14820									

Boom : 5.68 m (18' 8") / Arm : 2.4 m (7' 10") / Bucket : 0.92 m³ (1.20 yd³) SAE heaped / Shoe : 800 mm (32") triple grouser with 3,800 kg (8,380 lb) Counterweight

Load point height m (ft)		Load radius								At max. reach						
		1.5 m (5.0 ft)		3.0 m (10.0 ft)		4.5 m (15.0 ft)		6.0 m (20.0 ft)		7.5 m (25.0 ft)		Capacity	Reach			
															m (ft)	
7.5 m (25.0 ft)	kg lb												*3700 *8160	*3700 *8160	7.31 (24.0)	
6.0 m (20.0 ft)	kg lb							*4050 *8930	*4050 *8930				*3790 *8360	3570 7870	8.30 (27.2)	
4.5 m (15.0 ft)	kg lb					*5360 *11820	*5360 *11820	*4580 *10100	*4580 *10100	*4260 *9390	4130 9110		*3920 *8640	3110 6860	8.87 (29.1)	
3.0 m (10.0 ft)	kg lb					*7130 *15720	*7130 *15720	*5390 *11880	*5390 *11880	*4610 *10160	4010 8840		*4080 *8990	2890 6370	9.12 (29.9)	
1.5 m (5.0 ft)	kg lb			*8720 *19220	*8720 *19220	*8580 *18920	*8580 *18920	*6220 *13710	*6220 *13710	*5020 *11070	*3870 8530		*4110 9060	2860 6310	9.08 (29.8)	
Ground Line	kg lb			*9350 *20610	*9350 *20610	*9550 *21050	8290 18280	*6790 *14970	5310 11710	*5320 *11730	3780 8330		4340 9570	3020 6660	8.75 (28.7)	
-1.5 m (-5.0 ft)	kg lb	*10290 *22690	*10290 *22690	*14180 *31260	*14180 *31260	*9620 *21210	8230 18140	*6950 *15320	5240 11550				*4650 *10250	3450 7610	8.07 (26.5)	
-3.0 m (-10.0 ft)	kg lb	*14760 *32540	*14760 *32540	*12990 *28640	*12990 *28640	*8950 *19730	8330 18360	*6470 *14260	5310 11710				*4690 *10340	4470 9850	6.94 (22.8)	
-4.5 m (-15.0 ft)	kg lb			*10150 *22380	*10150 *22380	*7020 *15480	*7020 *15480									

Boom : 5.68 m (18' 8") / Arm : 2.92 m (9' 7") / Bucket : 0.92 m³ (1.20 yd³) SAE heaped / Shoe : 800 mm (32") triple grouser with 3,800 kg (8,380 lb) Counterweight

Load point height m (ft)		Load radius								At max. reach					
		1.5 m (5.0 ft)		3.0 m (10.0 ft)		4.5 m (15.0 ft)		6.0 m (20.0 ft)		7.5 m (25.0 ft)		Capacity	Reach		
															m (ft)
7.5 m (25.0 ft)	kg lb												*3370 *7430	*3370 *7430	7.93 (26.0)
6.0 m (20.0 ft)	kg lb									*2700 *5950	*2700 *5950		*3460 *7630	3220 7100	8.83 (29.0)
4.5 m (15.0 ft)	kg lb							*4110 *9060	*4110 *9060	*3870 *8530	*3870 *8530		*3600 *7940	2820 6220	9.37 (30.7)
3.0 m (10.0 ft)	kg lb			*10440 *23020	*10440 *23020	*6440 *14110	*6440 *14110	*4960 *10930	*4960 *10930	*4290 *9460	4030 8880		*3760 *8290	2640 5820	9.60 (31.5)
1.5 m (5.0 ft)	kg lb			*8610 *18980	*8610 *18980	*8150 *17970	*8150 *17970	*5860 *12920	5520 12170	*4760 *10490	3870 8530		*3760 8290	2610 5750	9.57 (31.4)
Ground Line	kg lb			*9870 *21760	*9870 *21760	*9260 *20410	8290 18280	*6560 *14460	5300 11680	*5150 *11350	3750 8270		3940 8690	2730 6020	9.25 (30.3)
-1.5 m (-5.0 ft)	kg lb	*9210 *20300	*9210 *20300	*13090 *28860	*13090 *28860	*9600 *21160	8150 17970	*6880 *15170	5180 11420	*5300 *11680	3690 8140		*4340 *9570	3060 6750	8.62 (28.3)
-3.0 m (-10.0 ft)	kg lb	*12660 *27910	*12660 *27910	*13780 *30380	*13780 *30380	*9230 *20350	8200 18080	*6670 *14700	5200 11460				*4470 *9850	3810 8400	7.59 (24.9)
-4.5 m (-15.0 ft)	kg lb			*11470 *25290	*11470 *25290	*7860 *17330	*7860 *17330						*4250 *9370	*4250 *9370	5.89 (19.3)















- Lifting capacity is based on SAE J1097, ISO 10567.
- Lifting capacity of the Robex Series does not exceed 75% of the tipping load with the machine on firm, level ground or 87% of full hydraulic capacity.
- The load point is a hook located on the back of the bucket.
- (*) indicates the load limited by hydraulic capacity.

Lifting Capacities

R210LC-9 HIGH WALKER

















 Rating over-front  Rating over-side or 360 degrees

Boom : 5.68 m (18' 8") / Arm : 3.9 m (12' 10") / Bucket : 0.92 m³ (1.20 yd³) SAE heaped / Shoe : 800 mm (32") triple grouser with 3,800 kg (8,380 lb) Counterweight

Load point height m (ft)		Load radius												At max. reach						
		1.5 m (5.0 ft)		3.0 m (10.0 ft)		4.5 m (15.0 ft)		6.0 m (20.0 ft)		7.5 m (25.0 ft)		9.0 m (30.0 ft)		Capacity		Reach				
																m (ft)				
9.0 m (30.0 ft)	kg lb																*2750 *6060	*2750 *6060	7.86 (25.8)	
7.5 m (25.0 ft)	kg lb									*2220 *4890	*2220 *4890						*2810 *6190	*2810 *6190	9.06 (29.7)	
6.0 m (20.0 ft)	kg lb									*2850 *6280	*2850 *6280						*2910 *6420	2620 5780	9.85 (32.3)	
4.5 m (15.0 ft)	kg lb									*3140 *6920	*3140 *6920	*2180 *4810	*2180 *4810				*3030 *6680	2340 5160	10.33 (33.9)	
3.0 m (10.0 ft)	kg lb							*4060 *8950	*4060 *8950	*3620 *7980	*3620 *7980	*2990 *6590	2920 6440				*3180 *7010	2190 4830	10.54 (34.6)	
1.5 m (5.0 ft)	kg lb			*11630 *25640	*11630 *25640	*6880 *15170	*6880 *15170	*5070 *11180	*5070 *11180	*4190 *9240	3870 8530	*3490 *7690	2820 6220				3170 6990	2160 4760	10.50 (34.4)	
Ground Line	kg lb	*5540 *12210	*5540 *12210	*10590 *23350	*10590 *23350	*8400 *18520	8310 18320	*5960 *13140	5270 11620	*4710 *10380	3700 8160	*3480 *7670	2730 6020				3280 7230	2230 4920	10.22 (33.5)	
-1.5 m (-5.0 ft)	kg lb	*7800 *17200	*7800 *17200	*11920 *26280	*11920 *26280	*9220 *20330	8010 17660	*6540 *14420	5080 11200	*5060 *11160	3580 7890						3590 7910	2950 5400	9.67 (31.7)	
-3.0 m (-10.0 ft)	kg lb	*10330 *22770	*10330 *22770	*14530 *32030	*14530 *32030	*9340 *20590	7940 17500	*6690 *14750	5010 11050	*5090 *11220	3550 7830						*3920 *8640	2900 6390	8.78 (28.8)	
-4.5 m (-15.0 ft)	kg lb	*13390 *29520	*13390 *29520	*13120 *28920	*13120 *28920	*8690 *19160	8050 17750	*6230 *13730	5080 11200								*4030 *8880	3910 8620	7.41 (24.3)	
-6.0 m (-20.0 ft)	kg lb			*10090 *22240	*10090 *22240	*6720 *14820	*6720 *14820													

R210LC-9 LONG REACH

Boom : 8.2 m (26' 11") / Arm : 6.3 m (20' 8") / Bucket : 0.52 m³ (0.68 yd³) SAE heaped / Shoe : 800 mm (32") triple grouser with 5,300 kg (11,680 lb) Counterweight

Load point height m (ft)		Load radius												At max. reach						
		4.5 m (15.0 ft)		6.0 m (20.0 ft)		7.5 m (25.0 ft)		9.0 m (30.0 ft)		10.5 m (35.0 ft)		12.0 m (40.0 ft)		13.5 m (45.0 ft)		Capacity		Reach		
																		m (ft)		
10.5 m (35.0 ft)	kg lb																	*1480 *3260	*1480 *3260	12.11 (39.7)
9.0 m (30.0 ft)	kg lb											*930 *2050	*930 *2050					*1510 *3330	*1510 *3330	13.11 (43.0)
7.5 m (25.0 ft)	kg lb											*1550 *3420	*1550 *3420					*1550 *3420	1320 2910	13.84 (45.4)
6.0 m (20.0 ft)	kg lb									*1600 *3530	*1600 *3530	*1610 *3550	*1610 *3550					*1600 *3530	1160 2560	14.37 (47.1)
4.5 m (15.0 ft)	kg lb									*1790 *3950	*1790 *3950	*1730 *3810	1720 3790	*1260 *2780	*1260 *2780			*1660 *3660	1050 2310	14.72 (48.3)
3.0 m (10.0 ft)	kg lb					*2520 *5560	*2520 *5560	*2220 *4890	*2220 *4890	*2020 *4450	*2020 *4450	*1880 *4140	1630 3590	*1590 *3510	1220 2690			*1720 *3790	980 2160	14.89 (48.9)
1.5 m (5.0 ft)	kg lb	*5620 *12390	*5620 *12390	*3940 *8690	*3940 *8690	*3090 *6810	*3090 *6810	*2590 *5710	*2590 *5710	*2270 *5000	2000 4410	*2050 *4520	1530 3370	*1790 *3950	1170 2580			*1800 *3970	940 2070	14.90 (48.9)
Ground Line	kg lb	*6990 *15410	6720 14820	*4770 *10520	4490 9900	*3620 *7980	3240 7140	*2950 *6500	2430 5360	*2510 *5530	1860 4100	*2220 *4890	1440 3170	*1820 *4010	1110 2450			1880 4140	930 2050	14.75 (48.4)
-1.5 m (-5.0 ft)	kg lb	*7830 *17260	6210 13690	*5390 *11880	4120 9080	*4060 *8950	2990 6590	*3260 *7190	2260 4980	*2740 *6040	1740 3840	*2380 *5250	1360 3000	*1570 *3460	1070 2360			1930 4250	960 2120	14.42 (47.3)
-3.0 m (-10.0 ft)	kg lb	*8230 *18140	5990 13210	*5780 *12740	3920 8640	*4370 *9630	2830 6240	*3490 *7690	2140 4720	*2900 *6390	1660 3660	*2490 *5490	1310 2890					2030 4480	1020 2250	13.92 (45.7)
-4.5 m (-15.0 ft)	kg lb	*8310 *18320	5940 13100	*5950 *13120	3830 8440	*4540 *10010	2740 6040	*3630 *8000	2070 4560	*3000 *6610	1620 3570	*2510 *5530	1290 2840					*2210 *4870	1140 2510	13.20 (43.3)
-6.0 m (-20.0 ft)	kg lb	*8100 *17860	6010 13250	*5900 *13010	3840 8470	*4550 *10030	2730 6020	*3640 *8020	2060 4540	*2970 *6550	1620 3570							*2340 *5160	1330 2930	12.25 (40.2)
-7.5 m (-25.0 ft)	kg lb	*7580 *16710	6180 13620	*5610 *12370	3930 8660	*4350 *9590	2790 6150	*3460 *7630	2120 4670	*2740 *6040	1690 3730							*2460 *5420	1670 3680	10.97 (36.0)
-9.0 m (-30.0 ft)	kg lb	*6650 *14660	6460 14240	*4980 *10980	4110 9060	*3840 *8470	2940 6480	*2930 *6460	2260 4980											
-10.5 m (-35.0 ft)	kg lb	*5040 *11110	*5040 *11110	*3730 *8220	*3730 *8220															

- Lifting capacity is based on SAE J1097, ISO 10567.
- Lifting capacity of the Robex Series does not exceed 75% of the tipping load with the machine on firm, level ground or 87% of full hydraulic capacity.
- The load point is a hook located on the back of the bucket.
- (*) indicates the load limited by hydraulic capacity.

STANDARD EQUIPMENT

ISO Standard cabin

All-weather steel cab with 360° visibility
Safety glass windows
Rise-up type windshield wiper
Sliding fold-in front window
Sliding side window
One key fits all lockable doors
Hot & cool box
Storage compartment & Ashtray
Transparent cabin roof-cover
CD/MP3 Player with AUX-input
Handsfree mobile phone system with USB-charging device
Sun visor

Computer aided power optimization (New CAPO) system

3-power modes, 3-work modes, User mode
Auto & one-touch deceleration system
Auto warm-up system
Overheat prevention system

Self-diagnostics system

Starting Aid (air grid heater) for cold weather

Centralized monitoring

LCD display
Engine speed or Trip meter
Clock
Gauges
Fuel level gauge
Engine coolant temperature gauge
Hyd. oil temperature gauge
Warning lamps
Engine warning
Overload
Communication error
Low battery
Air filter clogging
Indicators
Max power
Low speed/High speed
Fuel warmer
Auto deceleration

Door and cab locks, one key

Two outside rearview mirrors

Fully adjustable suspension seat with seat belt

Adjustable joysticks

Console box tilting system (LH.)

Three frontal working lights

Electric horn

Batteries (2 x 12V x 100 AH)

Battery master switch

Removable clean-out screen for oil cooler

Automatic swing brake

Removable reservoir tank

Fuel pre-filter with fuel warmer

Boom holding system

Arm holding system

Counterweight (3,800 kg; 8,380 lb)

Track shoes (600 mm; 24")

Track rail guard

Viscous fan clutch

Accumulator for lowering work equipment

Electric transducer

Lower frame under cover

OPTIONAL EQUIPMENT

Fuel filler pump (50 L/min)

Beacon lamp

Safety lock valve for boom cylinder with overload warning device

Safety lock valve for arm cylinder

Single-acting piping kit (breaker, etc.)

Double-acting piping kit (clamshell, etc.)

Quick coupler

12 volt power outlet (24V DC to 12V DC converter)

Travel alarm

Boom

Short boom (5.68 m; 18' 8")

Long reach boom (8.2 m; 26' 11")

Arm

2.0 m; 6' 7"

2.4 m; 7' 10"

2.92 m; 9' 7"

3.9 m; 12' 10"

6.3 m; 20' 8" Long reach

Automatic climate control

Full-automatic air conditioner & heater

Semi-automatic air conditioner & heater

Air conditioner

Heater

Defroster

Cabin FOPS/FOG (ISO/DIS 10262)

FOPS (Falling Object Protective Structure)

FOG (Falling Object Guard)

Cabin roof-steel cover

Cabin lights

Rain guard - front window

Track shoes

Triple grousers shoe (700 mm; 28")

Triple grousers shoe (800 mm; 32")

Triple grousers shoe (900 mm; 36")

Double grousers shoe (710 mm; 28")

Full track rail guard (High walker only)

Additional cover under lower frame

Coolant pre-heating system

Tool kit

Operator suit

Low-noise kit

Rearview camera

Seat

Adjustable air suspension seat

Adjustable air suspension seat with heater

Mechanical suspension seat with heater

Pattern change valve (4 patterns)

Hi-mate (Remote Management System)

Standard and optional equipment may vary. Contact your Hyundai dealer for more information. The machine may vary according to International standards. All imperial measurements rounded off to the nearest pound or inch.

PLEASE CONTACT

