

STATIC DIMENSIONS

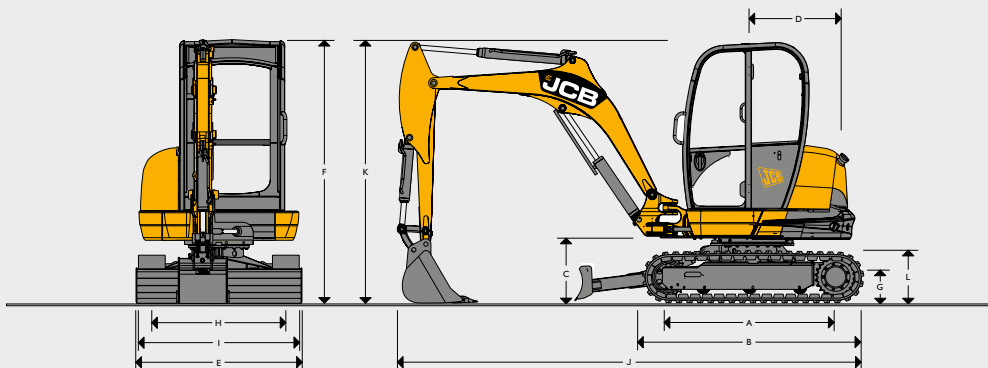

Machine model		8026 CTS	
A	Sprocket idler centres	mm (ft-in)	1440 (4-8¾)
B	Undercarriage overall length	mm (ft-in)	1870 (6-1¾)
C	Kingpost clearance	mm (ft-in)	528 (1-9)
D	Tailswing radius	mm (ft-in)	1220 (4-0)
E	Overall width of superstructure	mm (ft-in)	1550 (5-1)
F	Height over cab	mm (ft-in)	2400 (7-10½)
G	Ground clearance	mm (ft-in)	270 (0-10¾)
H	Track gauge	mm (ft-in)	1252 (4-1¼)
I	Width over tracks	mm (ft-in)	1502 (4-11)
J	Transport length	mm (ft-in)	4080 (13-4¾)
K	Transport height	mm (ft-in)	2400 (7-10½)
L	Track height	mm (ft-in)	455 (1-6)

ENGINE

Model	403D-15 Tier 3	
Fuel	Diesel	
Cooling	Water cooled	
Gross power	kW (hp) @ 2100 rpm	18.4 (24.7)
Nett power	kW (hp) @ 2100 rpm	16.5 (22.1)
Gross torque	Nm (lbf ft) @ 1800 rpm	96 (70.8)
Nett torque	Nm (lbf ft) @ 1800 rpm	90.4 (66.7)
Displacement	cc	1496
Gradeability	degrees	36
Starter motor	kW (hp)	2 (2.68)
Battery	volt/Ah	12 / 75
Alternator	amps	65

UNDERCARRIAGE

No of bottom rollers	3	
Track width	mm (in)	250 (10)
Ground bearing pressure	kg/cm²	0.40
Ground clearance	mm (in)	270 (0-10½)
Track tensioning	Grease	
Travel speed – low	kph (mph)	2.5 (1.6)
Travel speed – high	kph (mph)	4.9 (3.0)
Tractive effort	kN (lbf)	25 (5620)

HYDRAULIC SYSTEM





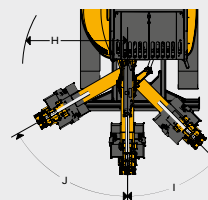
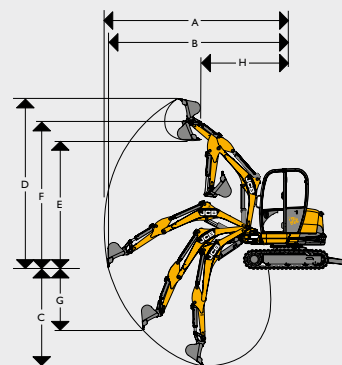









Pump	2 Variable & 1 Gear	
Nominal output @ 2250 rpm	lpm	96
Nominal output @ 2250 rpm	US gal/min	25.4
Excavator/track main relief	bar (psi)	235 (3408)
Slew main relief	bar (psi)	190 (2756)
Auxiliary hydraulic flow	litres (US gal)	59 (15.6)
Hydraulic motors	Piston	

WORKING RANGE



Boom length	mm (ft-in)	2130 (7-0)
Dipper length	mm (ft-in)	1300 (4-3¼)
A Max digging reach	mm (ft-in)	4770 (15-7¾)
B Max digging reach on ground	mm (ft-in)	4660 (15-3½)
C Max digging depth – dozer up	mm (ft-in)	2740 (9-0)
Max digging depth – dozer down	mm (ft-in)	3050 (10-0)
D Max digging height	mm (ft-in)	4495 (14-9)
E Max dump height	mm (ft-in)	3220 (10-6¾)
F Max height to dipper nose pivot pin	mm (ft-in)	3830 (12-6¾)
G Max vertical wallcut depth	mm (ft-in)	2080 (6-10)
H Min. front swing radius (no offset)	mm (ft-in)	2045 (6-8½)
Min. front swing radius (fully offset)	mm (ft-in)	1870 (6-1¾)
I Boom swing left	degrees	45
J Boom swing right	degrees	60
Bucket rotation	degrees	189
Dipper rotation	degrees	119
Bucket tearout	kN (lbf)	23 (5170)
Dipper tearout	kN (lbf)	17 (3822)
Slew speed	rpm	9.6

**LIFT CAPACITIES – Standard dozer, 250mm (10in) rubber tracks, 1300mm (4ft-2¼in) dipper, no bucket.**

Load Point	Reach from slew centre																
	2.5m (8ft 2½in)			3.0m (9ft 10in)			3.5m (11ft 6in)			4.0m (13ft 1in)			Capacity at maximum reach				
Height	 Dozer up	 Dozer down	 Full circle	 Dozer up	 Dozer down	 Full circle	 Dozer up	 Dozer down	 Full circle	 Dozer up	 Dozer down	 Full circle	 Dozer up	 Dozer down	 Full circle		
m (ft-in)	kg	kg	kg	kg	kg	kg	kg	kg	kg	kg	kg	kg	kg	kg	kg	kg	mm
2.0 (6-7)	588*	588*	588*	584*	584*	584*	594*	594*	458	-	-	-	424	614*	394	3900	
1.5 (4-11)	778*	778*	778*	689*	689*	689*	494*	646*	452	389	637*	371	389	637*	371	4000	
1 (3-3)	786	1005*	718	586	806*	543	482	713*	439	388	660*	365	388	660*	365	4000	
0.5 (1-8)	752	1142*	696	596	918*	542	464	769*	437	381	689*	369	381	689*	369	4000	
Ground Level	742	1255*	676	576	983*	524	461	812*	433	-	-	-	401	734*	377	3900	
-0.5 -(1-8)	695	1240*	649	566	1002*	515	465	801*	428	-	-	-	437	754*	405	3650	
-1 -(3-3)	711	1179*	649	566	940*	524	-	-	-	-	-	-	475	787*	453	3350	

 Lift capacity front and rear.

- Notes:**
- Lifting capacities are based on ISO 10567, that is: 75% of minimum tipping load or 87% of hydraulic lift capacity, whichever is the less. Lifting capacities marked\* are based on hydraulic capacity.
  - Lift capacities assume that the machine is on firm, level ground and equipped with an approved lifting point.
  - A bucket must be fitted when lifting, the weight of this bucket must be deducted from the above lift capacities.
  - Lift capacities may be limited by local regulations. Please refer to your dealer.

 Lift capacity full circle.

**OPERATOR ENVIRONMENT**

Cab/canopy height	mm (ft-in)	1517 (4-11¾)
Cab/canopy length	mm (ft-in)	1205 (3-11½)
Cab/canopy width	mm (ft-in)	980 (3-2½)
Door aperture width	mm (ft-in)	532 (1-9)

**SERVICE CAPACITIES**

Fuel tank	litres (US gal)	56 (14.8)
Engine coolant	litres (US gal)	8.5 (2.0)
Engine oil	litres (US gal)	4.5 (1.2)
Hydraulic system	litres (US gal)	71 (18.8)
Hydraulic tank	litres (US gal)	45 (11.9)

**DOZER BLADE**

Max height (above ground)	mm (ft-in)	333 (1¼)
Dig depth (below ground)	mm (ft-in)	405 (1-4)
Approach angle	degrees	31
Width	mm (ft-in)	1550 (5-1)
Height	mm (ft-in)	268 (0-10½)
Reach in front of tracks	mm (ft-in)	342 (1-1½)

**EEC NOISE LEVELS (95/27/EC DYNAMIC)**

Cab / canopy external	dB (LwA)	93
Cab internal	dB (LpA)	78

**MACHINE WEIGHTS**

Operating weight*	kg (lb)	2867 (6321)
With canopy	kg (lb)	- 100 - (220.5)
With steel tracks	kg (lb)	+ 84 + (185)

\*Operating weight to ISO 6016 including cab, rubber tracks, standard dipper, 300mm (12in) bucket, full tanks and a 75kg (165lb) operator.

**STANDARD EQUIPMENT**

ROPS & TOPS certified canopy, full audio/visual warning systems, slew travel lock, control isolator, internal lockable toolbox, 12v power socket, lifting points, 250mm short pitch rubber tracks, ISO servo controls, static seat, track pedals, boom ram protection, maxi-lift dozer blade, 1300mm dipper, auto kickdown track motors, in cab stowage facility, battery isolator (EU only).

**OPTIONAL EQUIPMENT**

ROPS & TOPS certified fully glazed cab (includes heater, interior light, foldback door, gas strut assisted front screen), suspension seat, 250mm steel tracks, electro-proportional thumb controlled auxiliary, dual pattern controls (ISO/SAE change-over), cab/canopy mounted worklights, single acting auxiliary circuit, double acting auxiliary circuit, engine fan guard, FOPS roof guard, mirror, toolkit, radio, biodegradeable hydraulic oil, fire extinguisher, sunblind (cab builds), battery isolator; Datatag (UK only), travel alarm, immobiliser, hose burst check valves on boom, dipper and dozer, bucket to grab changeover, 1100mm dipper, digging buckets (230mm to 600mm), 1000mm ditching/grading bucket, hydraulic breakers, earthdrill, mechanical quickhitch, hydraulic kerb-lifter, bushed king post.